

***** 一般男子シングルス予選 (1) *****

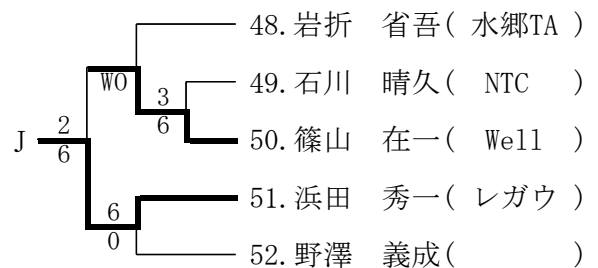

***** 一般男子シングルス予選 (2) *****

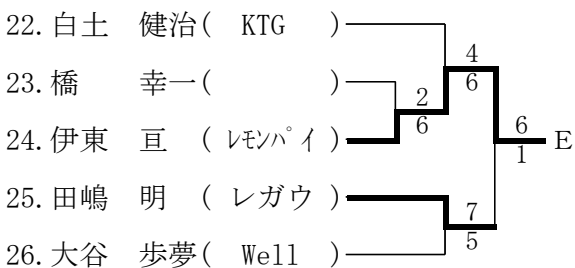
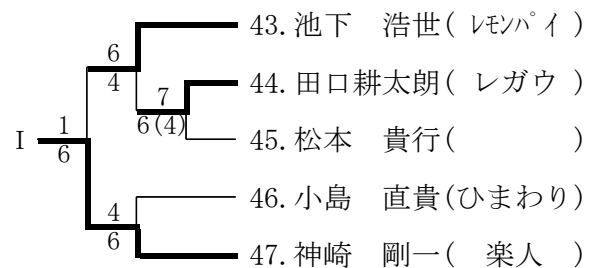
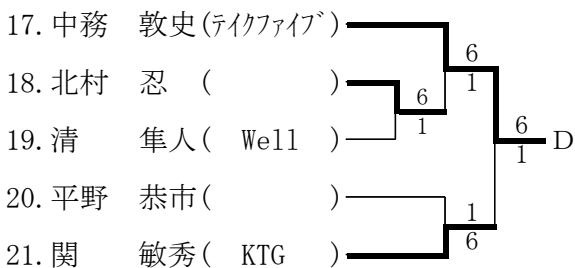
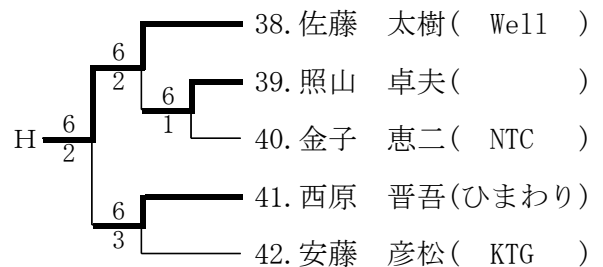
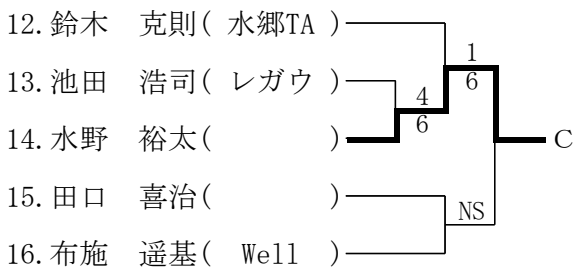
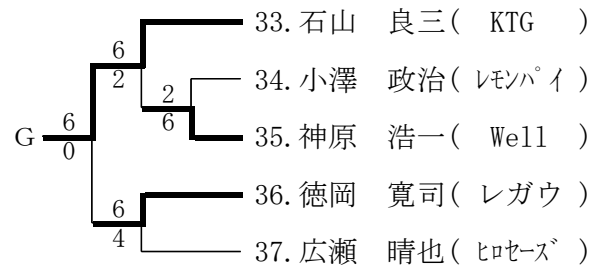
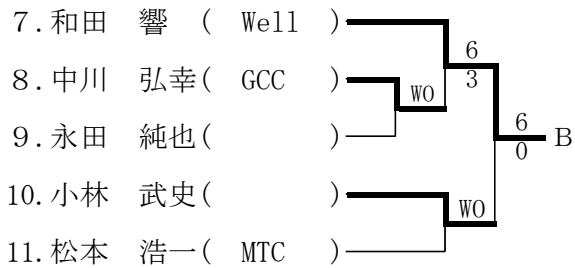
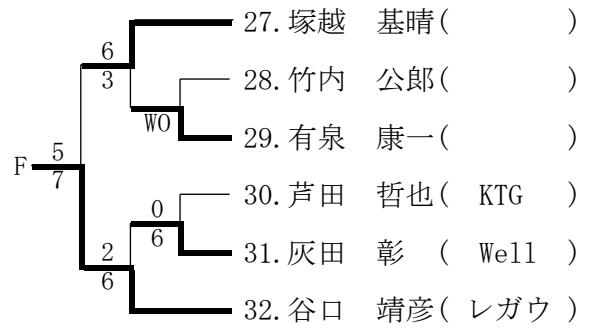
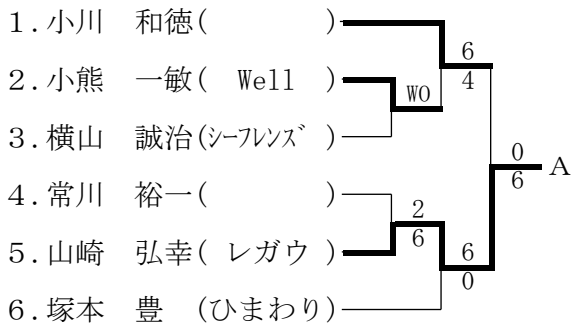
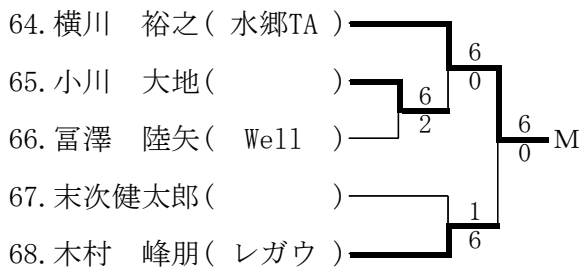
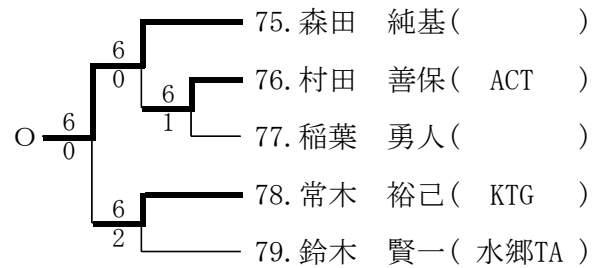
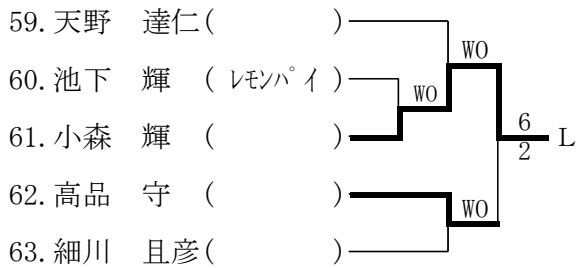
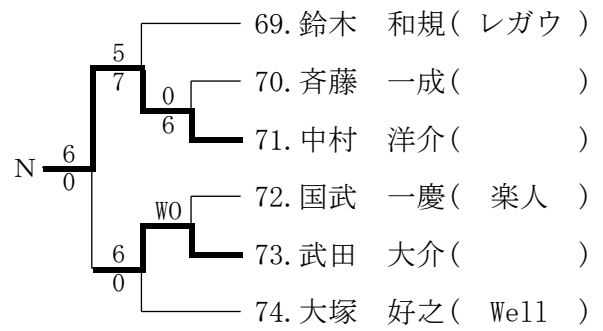
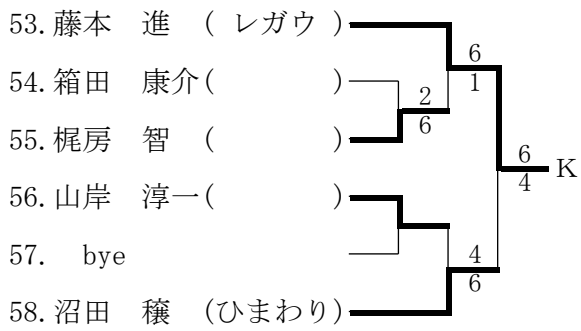

***** 壮年男子45オシングルス *****

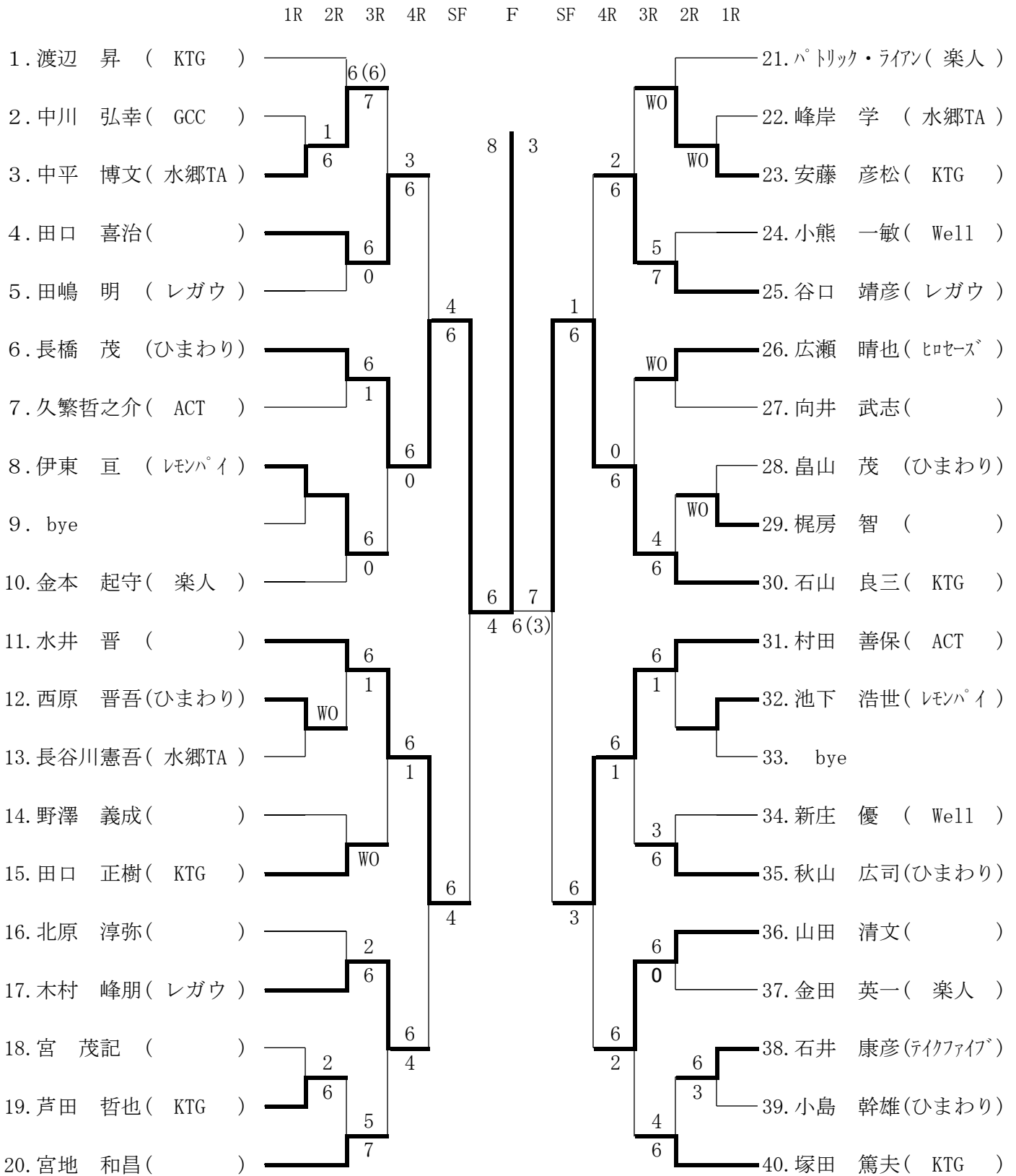

シード順位

1. 渡辺 昇 (KTG) 2. 塚田 篤夫(KTG) 3. 石山 良三(KTG) 4. 水井 晋()

***** 一般女子シングルス *****

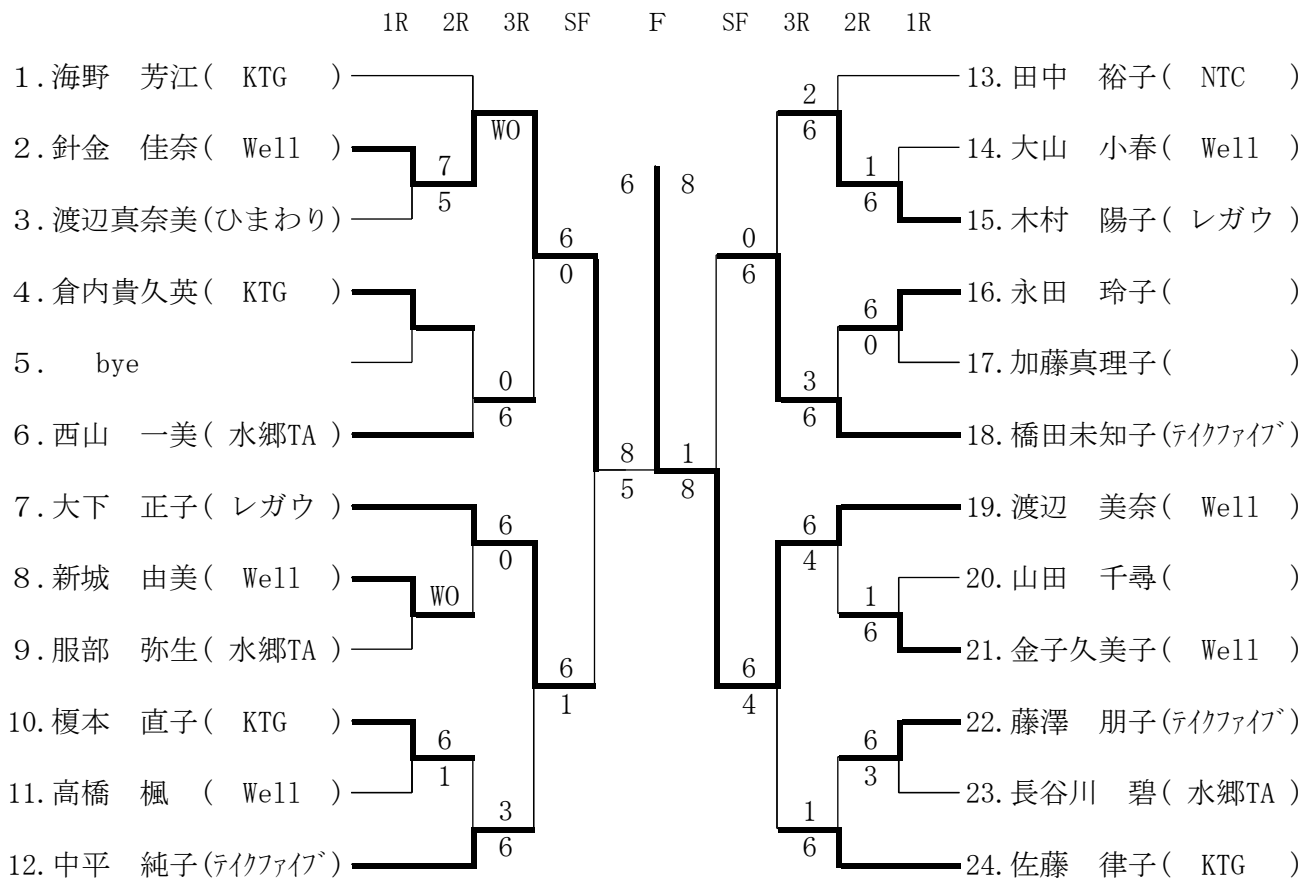

シード順位

1. 海野 芳江 (KTG) 2. 佐藤 律子 (KTG) 3. 橋田未知子(テイクファイブ) 4. 大下 正子(レガウ)

***** 壮年男子55オシングルス *****

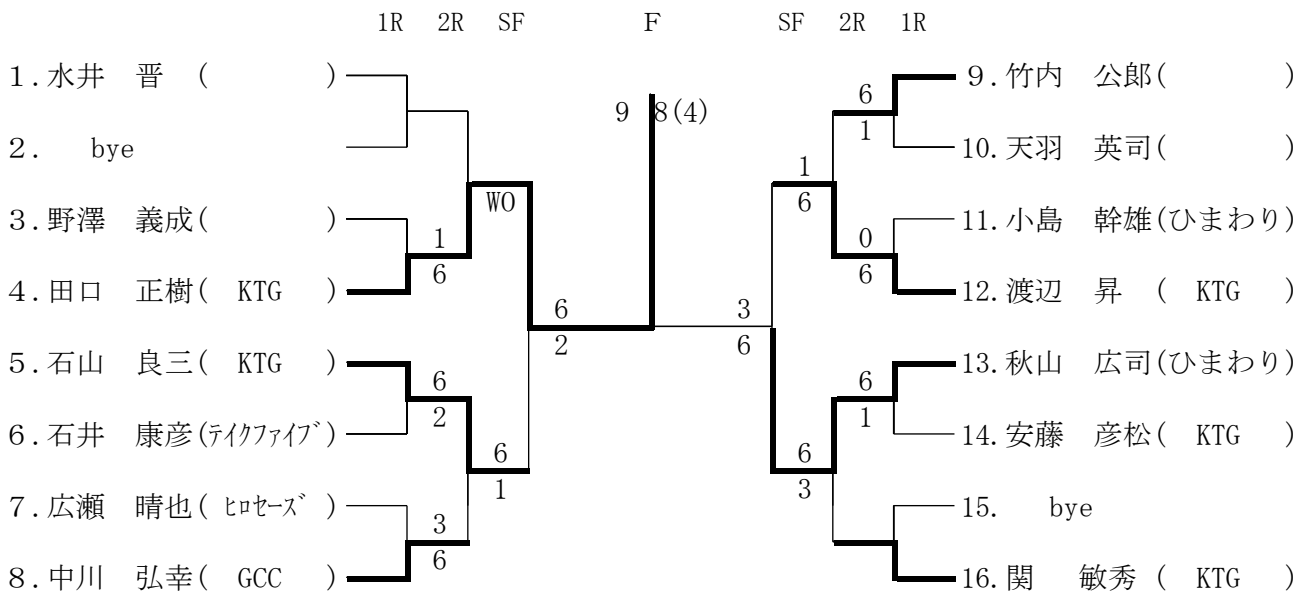

シード順位

1. 水井 晋 () 2. 関 敏秀 (KTG)